

# Avdel® Nutsert® / TSN®

The Avdel Thin Sheet Nutsert® is a blind threaded insert designed to provide load bearing threads in thin sheet materials. The large flange version gives the Thin Sheet Nutsert rivet nut a greater load bearing surface whilst a closed end prevents the ingress of dirt and fluids into the thread and electrical circuits

## Key features and benefits

- Can be used in very thin sheet materials from 0.50mm (0.02")
- Access needed from only one side of the application, for high speed assembly
- Provides a female thread in application
- Can be installed in pre-coated or post painted applications without damaging the surface
- Various platings available to increase the corrosion resistance
- Low profile head allows near flush fit to application and clamps two or more sheets of material together, within the grip range
- Large flange head provides a load bearing surface and reinforces the hole to prevent push-out. Can be used as a spacer and can be supplied with an under-head seal
- Closed end prevents the ingress of dirt and fluids into thread and electrical circuits
- Can be used with hand tools, pneumatic tools and fully automated machines to suit a wide range of assembly methods



The Avdel Thin Sheet Nutsert® are available in sizes M3 – 10. They are available in low profile, countersunk and large flange head forms and manufactured in steel, stainless and aluminium.

Authorised UK distributors for:

# Nutsert® / TSN® 9658



Avdel thin sheet, low profile, open ended steel nutsert available in sizes M3 – M10.

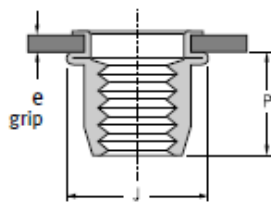
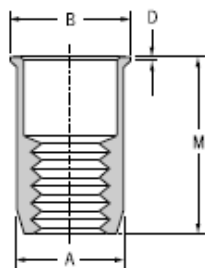

Low carbon steel\*

Zinc plated  
Clear trivalent passivated  
Lubricated

Ø	e (grip)		+0.1/-0	A max.	B max.	D max.	J max.	M max.	P max.	Part No/ref
	min.	max.								
M3 x 0.5	0.51	1.50	4.75	4.72	5.84	0.38	8.40	9.02	5.80	09658-70310
M4 x 0.7	0.51	2.00	6.35	6.32	7.30	0.51	10.30	10.41	7.20	09658-70413
M5 x 0.8	0.51	3.00	7.15	7.11	8.00	0.51	12.70	11.81	7.00	09658-70514
M6 x 1.0	0.76	3.25	9.55	9.50	10.67	0.76	15.50	14.60	9.50	09658-70619
M8 x 1.25	0.91	3.70	10.60	10.57	11.68	0.76	17.20	16.00	10.10	09658-75821
M10 x 1.5	1.00	3.60	14.20	14.17	16.20	0.76	23.30	18.50	10.50	09658-72022

# Nutsert® / TSN® FS38



Avdel thin sheet, low profile, closed ended steel nutsert available in sizes M3 – M8.

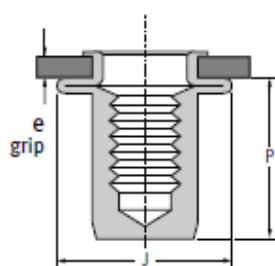
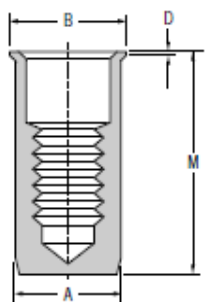

Ø	e (grip)		+0.1/-0	A max.	B max.	D max.	J max.	M max.	P max.	Part No/ref
	min.	max.								
M4 x 0.7	0.51	2.00	6.35	6.34	7.50	0.64	10.00	14.91	11.70	0FS38-70418
M5 x 0.8	0.51	3.00	7.15	7.13	8.26	0.64	12.20	20.26	15.50	0FS38-70521
M6 x 1.0	0.76	3.25	9.53	9.52	10.85	0.77	15.00	23.49	18.60	0FS38-70626
M8 x 1.25	0.91	3.70	10.60	10.59	11.74	0.77	16.80	23.63	18.10	0FS38-70829

Authorised UK distributors for:

Avdel southco

BBA

DEJOND

GESIPA

EJOT

# Nutsert® / TSN® FS58



Avdel thin sheet, large flange, closed ended steel nutsert available in sizes M3 – M8.

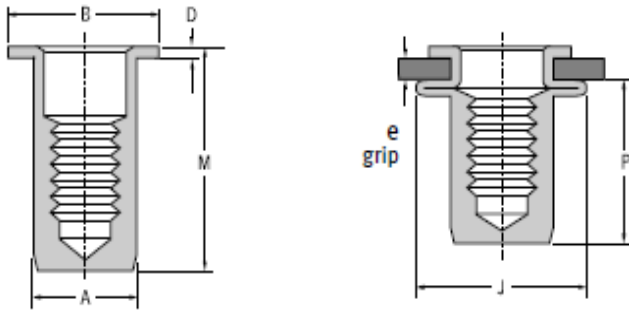



Ø	e (grip)		 +0.1/-0	A	B	D	J	M	P	Part No/ref
	min.	max.		max.	max.	± 0.13	max.	max.	max.	
M4 x 0.7	0.50	2.50	6.10	6.05	9.30	0.80	10.50	16.64	12.10	0FS58-70421
M5 x 0.8	0.50	2.50	7.10	7.05	10.30	1.00	13.30	17.56	12.30	0FS58-70522
M6 x 1.0	0.50	3.00	9.10	9.05	13.30	1.50	15.00	22.48	16.00	0FS58-70628
M8 x 1.25	1.00	4.00	11.00	11.05	14.30	1.50	18.60	25.84	19.80	0FS58-70832

# Nutsert® / TSN® 9468

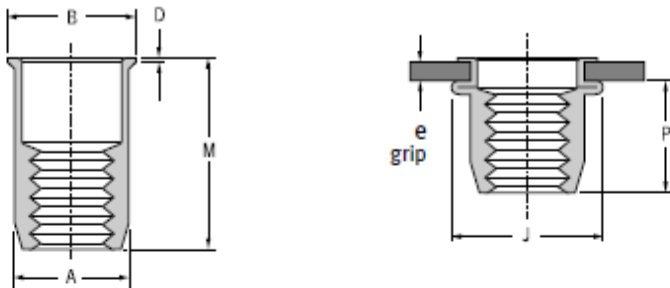

Avdel thin sheet, low profile, open ended stainless steel nutsert available in sizes M3 – M10.



Ø	e (grip)		 +0.1/-0	A	B	D	J	M	P	Part No/ref
	min.	max.		max.	max.	max.	max.	max.	max.	
M3 x 0.5	0.51	1.50	4.75	4.73	5.77	0.64	8.40	9.15	5.80	09468-00310
M4 x 0.7	0.51	2.00	6.35	6.32	7.50	0.64	10.30	10.42	7.20	09468-00413
M5 x 0.8	0.51	3.00	7.15	7.11	8.26	0.64	12.70	11.82	7.00	09468-00514
M6 x 1.0	0.76	3.25	9.53	9.50	10.85	0.77	15.50	14.61	9.50	09468-00619
M8 x 1.25	0.91	3.70	10.60	10.57	11.74	0.77	17.20	16.13	10.10	09468-05821
M10 x 1.5	1.00	3.60	14.30	14.28	15.80	0.77	23.30	18.62	10.50	09468-01023

Authorised UK distributors for:





# Nutsert® / TSN® GM17



Avdel thin sheet, low profile, open ended aluminium nutsert available in sizes M3 – M8.

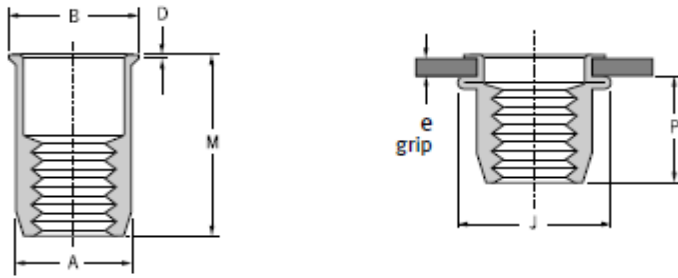

ø	e (grip)		+0.1/-0	A max.	B +0.3/-0.2	D +0.3/-0.1	J max.	M ± 0.35	P max.	Part No/ref
	min.	max.								
M4 x 0.7	0.50	3.00	6.10	6.00	6.50	0.50	8.10	10.75	6.80	0GM17-00430
M5 x 0.8	0.50	3.00	7.10	7.00	7.50	0.50	9.60	12.00	8.30	0GM17-00530
M6 x 1.0	0.50	3.00	9.10	9.00	9.50	0.50	12.10	14.50	10.00	0GM17-00630
M8 x 1.25	0.50	3.00	11.10	11.00	11.50	0.50	14.50	16.00	11.50	0GM17-00830

# Nutsert® / TSN® FW78



Avdel thin sheet, large flange, open ended aluminium nutsert available in sizes M3 – M10.

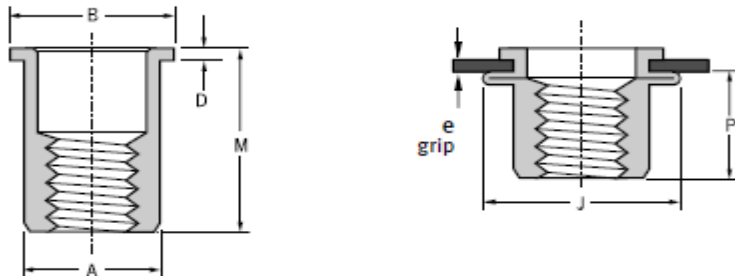

ø	e (grip)		+0.1/-0	A max.	B ± 0.35	D ± 0.15	J max.	M ± 0.35	P max.	Part No/ref
	min.	max.								
M3 x 0.5	0.25	2.00	5.10	5.00	8.00	0.75	7.00	10.50	6.50	0FW78-00320
	2.00	3.00						11.50		0FW78-00330
M4 x 0.7	0.25	3.00	6.10	6.00	10.00	0.75	8.10	11.50	6.80	0FW78-00430
	3.00	4.50						13.00		0FW78-00445
M5 x 0.8	0.25	3.00	7.10	7.00	11.00	1.00	9.60	13.00	8.30	0FW78-00530
	3.00	5.50						16.00		0FW78-00555
M6 x 1.0	0.50	3.00	9.10	9.00	13.00	1.50	12.10	16.00	10.00	0FW78-00630
	3.00	5.50						18.00		0FW78-00655
	5.50	8.00						20.50		0FW78-00680
M8 x 1.25	0.50	3.00	11.10	11.00	16.00	1.50	14.50	17.50	11.50	0FW78-00830
	3.00	5.50						20.00		0FW78-00855
	5.50	8.00						23.00		0FW78-00880
M10 x 1.5	0.80	3.50	12.50	12.40	18.50	2.25	16.50	22.00	14.70	0FW78-01035
	3.50	6.00						25.00		0FW78-01060

Authorised UK distributors for:

